

Entrematic LCU30H COMPATIBLE

Installation manual for the control panel of automations with one or two 24V motors

(translation of the original instructions)

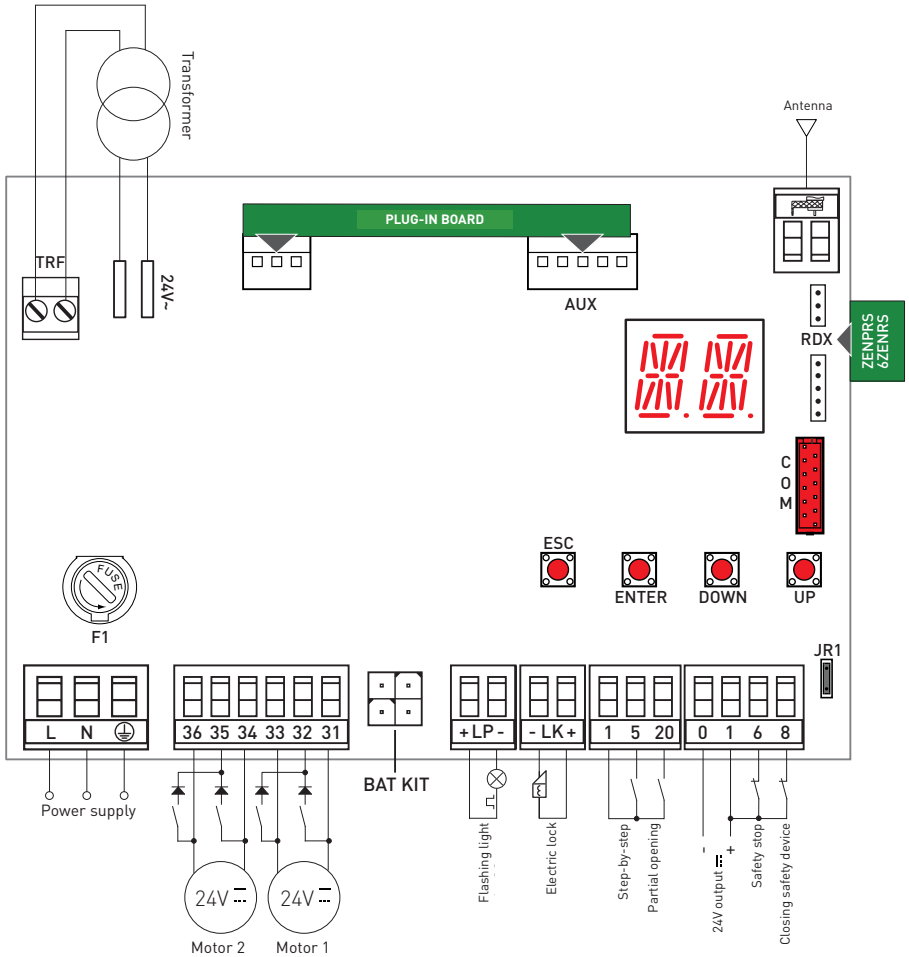

Contents

	Subject	Page
1.	General safety precautions	3
1.1	Safety functions	4
2.	EC Declaration of Conformity	4
3.	Technical specifications	4
3.1	Applications	4
4.	Installation and electrical connections	5
4.1	Maintenance	7
4.2	Standard installation	7
4.3	Connections diagram for standard installation	8
5.	Programming	9
5.1	Switching the display ON and OFF	9
5.2	Navigation keys	9
5.3	Menu map	10
6.	Quick start-up sequences	12
7.	Application examples	14
8.	Commands	15
8.1	SOFA1-SOFA2 or GOPAVRS self-controlled safety edge	15
9.	Outputs and accessories	16
10.	Jumper setting	17
11.	Adjustments	18
11.1	Main menu	18
11.2	Second level menu - AT (Automatic Configurations)	19
11.2.1	Selecting the type of automation AT → AS and specific default settings	20
11.3	Second level menu - BC (Basic Configurations)	20
11.3.1	Additional BC level parameters that can be configured (available with AT → AA enabled)	21
11.4	Second level menu - BA (Basic Adjustment)	22
11.4.1	Additional BA level parameters that can be configured (available with AT → AA enabled)	23
11.5	Second level menu - RO (Radio Operations)	26
11.5.1	Additional RO level parameters that can be configured (available with AT → AA enabled)	27
11.6	Second level menu - SF (Special Functions)	28
11.6.1	Additional SF level parameters that can be configured (available with AT → AA enabled)	29
11.7	Second level menu - CC (Cycle Counter)	30
11.7.1	Additional CC level parameters that can be configured (available with AT → AA enabled)	31
11.8	Second level menu - EM (Energy Management)	31
11.8.1	Additional EM level parameters that can be configured (available with AT → AA enabled)	32
11.9	Second level menu - AP (Advanced Parameters)	33
11.9.1	Additional AP level parameters that can be configured (available with AT → AA enabled)	34
12.	Signals visualised on the display	36
13.	Troubleshooting	41

Key



This symbol indicates instructions or notes regarding safety, to which special attention must be paid.



This symbol indicates useful information for the correct operation of the product.



Factory settings

1. General safety precautions



Failure to observe the information given in this manual may lead to personal injury or damage to the equipment.
Keep these instructions for future reference

This installation manual is intended for qualified personnel only. Installation, electrical connections and adjustments must be performed in accordance with Good Working Methods and in compliance with the present standards. This product must only be used for the specific purpose for which it was designed. Any other use is to be considered improper and therefore dangerous. The manufacturer cannot be held responsible for any damage caused by improper, incorrect or unreasonable use. Read the instructions carefully before installing the product. Incorrect installation may cause danger.

 The packaging materials (plastic, polystyrene, etc.) should not be discarded in the environment or left within reach of children, as they are a potential source of danger.

Before installing the product, make sure it is in perfect condition.

Do not install the product in explosive areas and atmospheres: the presence of inflammable gas or fumes represents a serious safety hazard.

 The safety devices (photocells, safety edges, emergency stops, etc.) must be installed taking into account the applicable laws and directives, Good Working Methods, installation premises, system operating logic and the forces developed by the automation.

Before connecting the power supply, make sure the plate data correspond to those of the mains power supply. An omnipolar disconnection switch with a contact opening distance of at least 3mm must be fitted on the mains supply.

Check that there is an adequate residual current circuit breaker and a suitable over-current cutout upstream of the electrical installation in accordance with Good Working Methods and with the laws in force.

 When requested, connect the automation to an effective earthing system that complies with current safety standards.

During installation, maintenance and repair operations, cut off the power supply before opening the cover to access the electrical parts.

The electronic parts must be handled using earthed antistatic conductive arms. The manufacturer of the motorisation device declines all responsibility if component parts not compatible with safe and correct operation are fitted.

Only use original spare parts when repairing or replacing products.

1.1 Safety functions

The Entrematic LCU30H control panel has the following safety functions:

- obstacle recognition with force limiting;

The maximum response time of the safety functions is 0.5 s. The reaction time to a faulty safety function is 0.5 s.

The safety functions comply with the standards and performance level indicated below:

EN ISO 13849-1:2015 Category 2 PL=c

EN ISO 13849-2:2012

The safety function cannot be bypassed either temporarily or automatically. Fault exclusion has not been applied.

2. EC Declaration of Conformity

Entrematic Group AB declares that the Entrematic LCU30H control panel complies with the fundamental requisites and other relevant requirements laid down by the following EC directives:

EMC Directive 2014/30/EU;

Low Voltage Directive 2014/35/EU.

RED Directive 2014/53/EU.

Landskrona, 01-07-2016

Matteo Fino
(President & CEO)



3. Technical specifications

	LCU30H	LCU30HJ
Power supply	230 V~ 50/60 Hz	120 V~ 50/60 Hz
Power absorption	0,6 A	1,2 A
Fuse	1,6 A	3,15 A
Motor output	24 V $\overline{\text{=}}$ 6 A max [X 2]	
Power supply to accessories 0-1	24 V $\overline{\text{=}}$ 0,5 A peak / 0,3 A continuous	
Ambient temperature	-20 °C - +55 °C	
Storable radio codes	100 / 200 see RO → MU → 20/10 (paragraph 11.6)	
Radio frequency	433,92 MHz	
Degree of protection of the container	IP55	
Product size	187 x 261 x 102	
Operating cycles	Refer to the characteristics of the actuator used.	

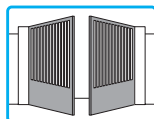
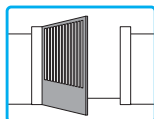

NB: the given operating and performance features can only be guaranteed with the use of DITEC Entrematic accessories and safety devices.

3.1 Applications



4. Installation and electrical connections

- Perforate the relevant points in the bottom part of the box (Fig. 4.1).
 - Fix the control panel permanently. You are advised to use round-head screws (max head \varnothing 10mm) with a cross (hole centre distance indicated in Fig. 4.2).
 - Insert the cable glands and corrugated tubes from the lower side of the container.
 - Before connecting the power supply, make sure the plate data correspond to those of the mains power supply.
 - An omnipolar disconnection switch with a contact opening distance of at least 3mm must be fitted on the mains supply.
 - Check there is an adequate residual current circuit breaker and overcurrent cutout upstream of the electrical system.
 - For the power supply, use a H05RN-F 3G1.5 type electric cable. Connect it to the terminals L (brown), N (blue), \oplus (yellow/green) inside the automation (Fig. 4.3, page 8).
- NB:** the maximum permitted wire section is AWG14 (2mm²).
- In order to comply with the essential requisites of the Standards in force, reclose the cover once the wires have been connected to the terminal.



The connections to the mains power supply and to any possible low voltage wires (230V) in the section outside the control panel must be made on an independent channel separated from the connections to the command and safety devices (SELV = Safety Extra Low Voltage). The corrugated tubes must enter the control panel by a few centimetres via the holes on the base box.

- Make sure there are no sharp edges that may damage the cables.
- Make sure the mains supply wires (230V) and the wires of the accessories (24V) are separated.
- The cables must have dual insulation, be sheathed near the relative connection terminals, and be held in place with ties [A] (not supplied).
- If necessary, fit the clip hinges on the bottom of the box and on the cover (left or right side, as preferred) (Fig. 4.4, page 8).

After making the adjustments and settings, fix the cover in place with the screws supplied (Fig. 4.5, page 8).

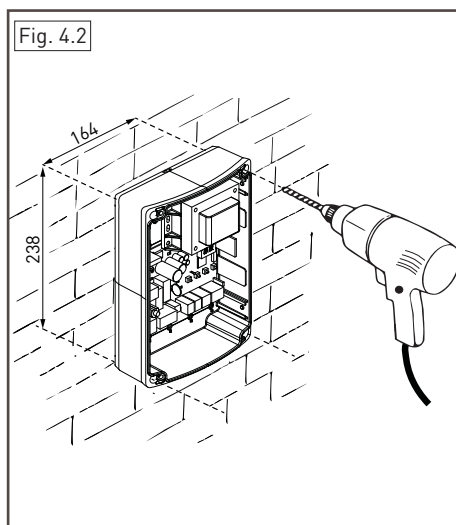
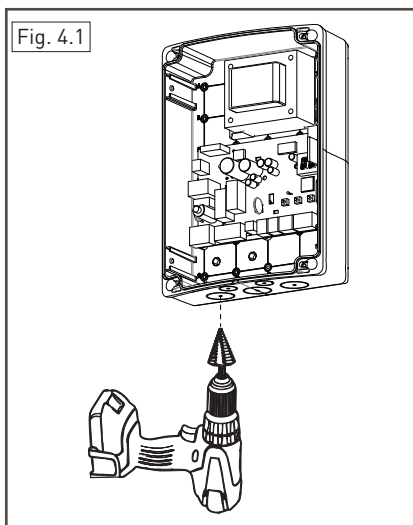

Fig. 4.3

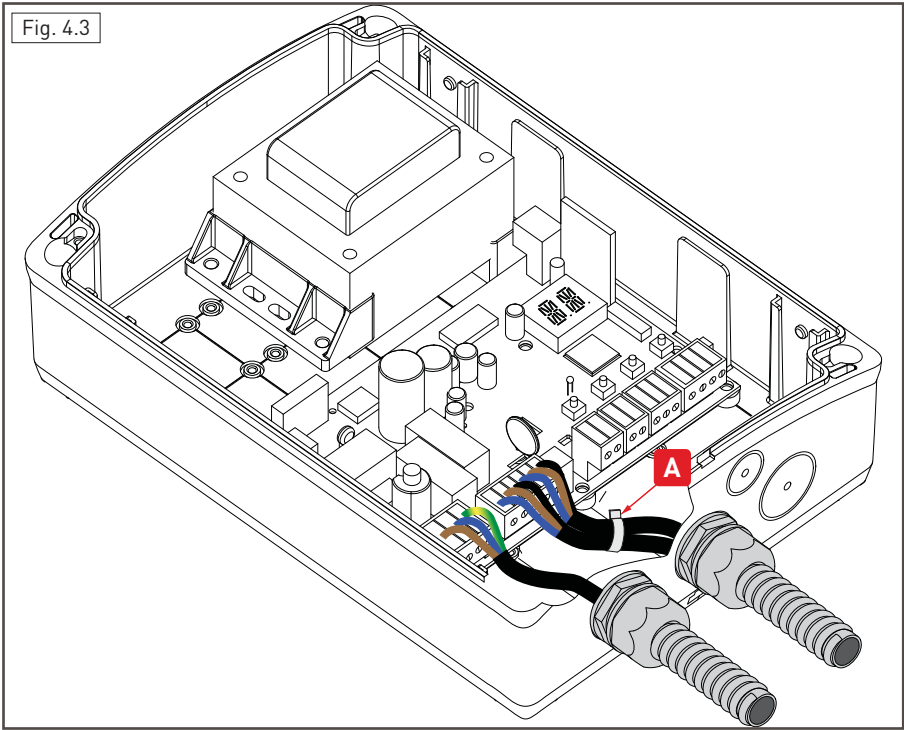

Fig. 4.4

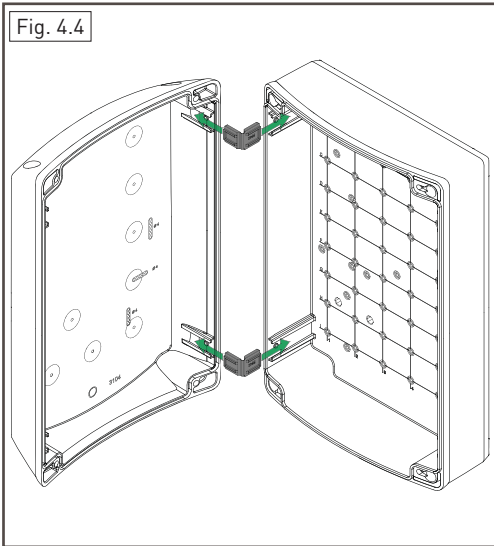
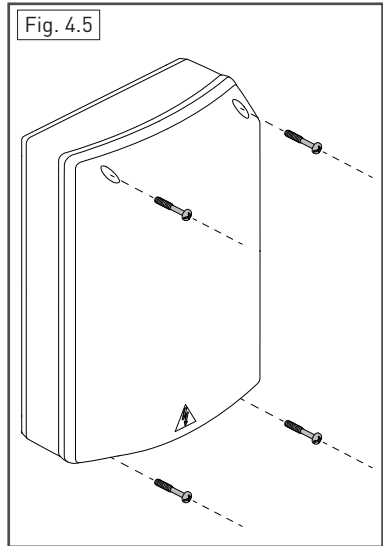

Fig. 4.5



4.1 Maintenance

The control panel doesn't require any special maintenance.

Make regular checks to ensure the seals on the box and the electrical connections are in good condition.

4.2 Standard installation

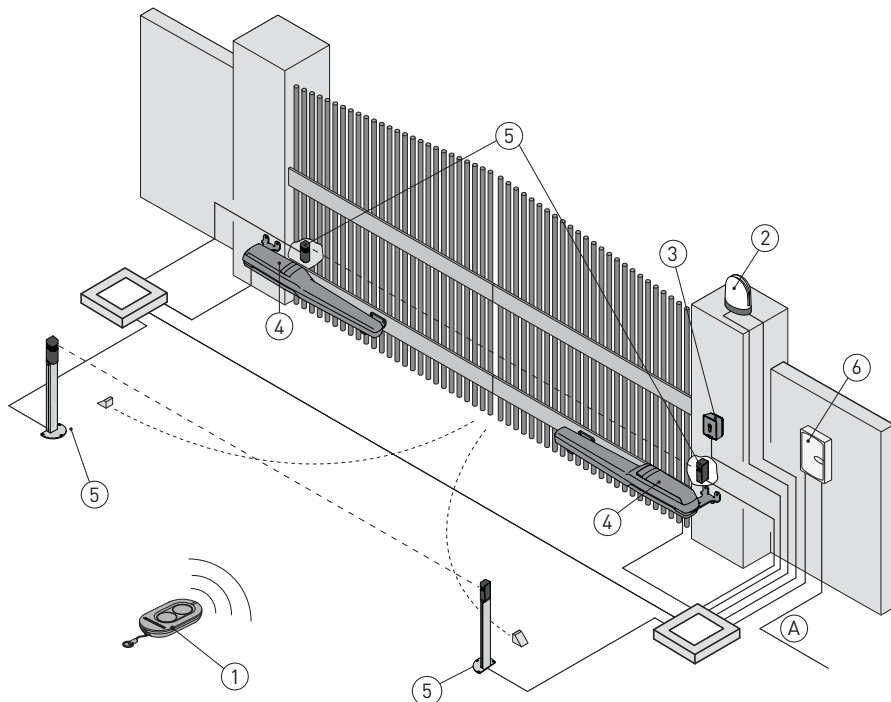

Ref.	Description	Cable
1	Transmitter	/
2	Flashing light Antenna (integrated in the flashing light)	2 x 1mm ² coaxial 50 Ω
3	Key selector switch Digital combination wireless keypad	4 x 0.5mm ² /
4	Actuator Actuator with limit switch	2 x 1.5mm ² 3 x 1.5mm ²
5	Photocells	4 x 0.5mm ²
6	Control panel	3G x 1.5mm ²
A	Connect the power supply to a type-approved omnipolar switch (not supplied), with a contact opening distance of at least 3mm. Connection to the mains must be via an independent channel, separated from the connections to the command and safety devices.	

4.3 Standard installation diagram

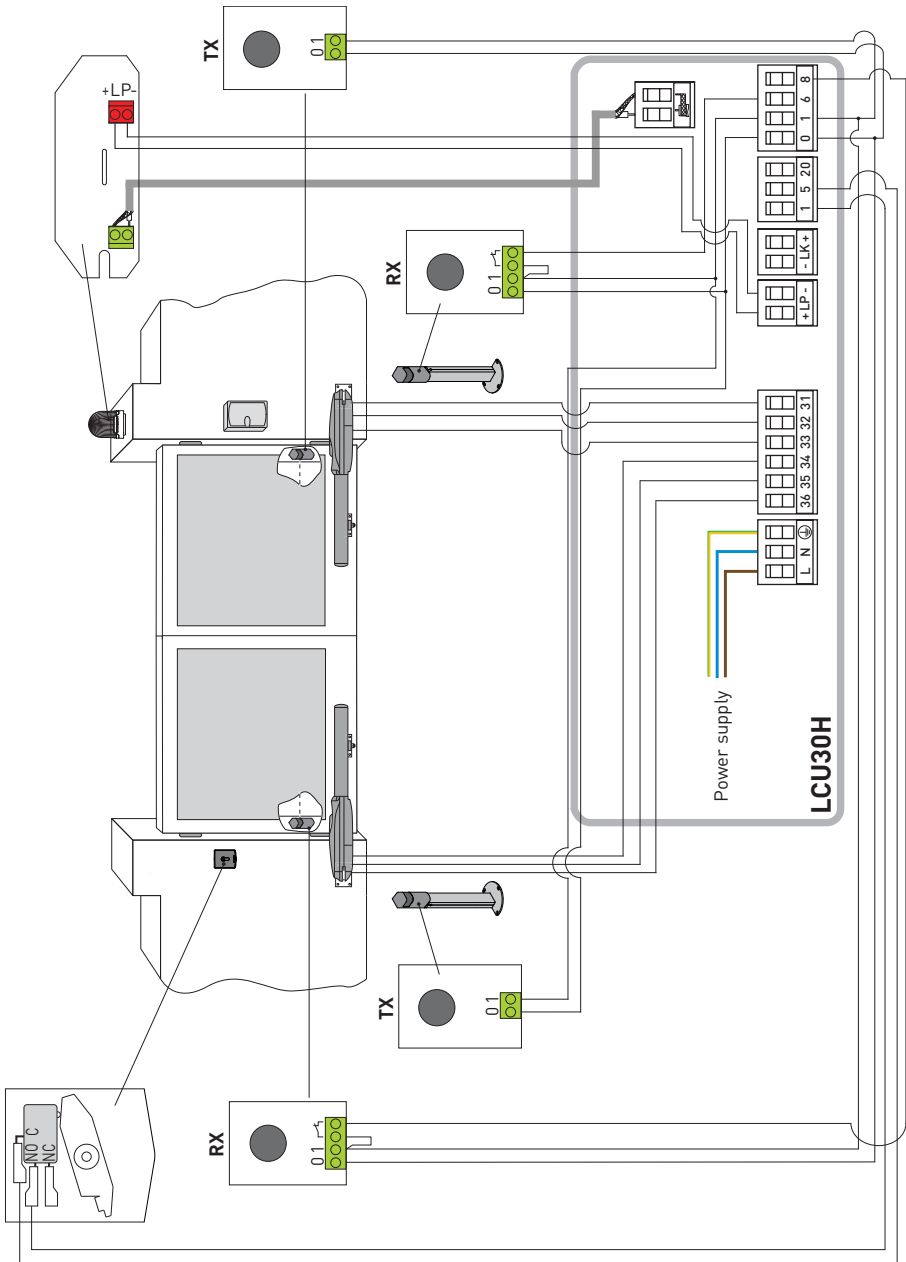

5. Programming



NB: pressure on the keys may be quick (less than 2 s) or prolonged (longer than 2 s). Unless specified otherwise, quick pressure is intended. To confirm the setting of a parameter, prolonged pressing is necessary.

5.1 Switching the display ON and OFF

The procedure to switch on the display is as follows:



- press the ENTER key
- the display functioning check starts
- the first level menu is displayed

The procedure to switch off the display is as follows:

- press the ESC key

NB: the display switches off automatically after 60 s of inactivity.

5.2 Navigation keys

- The simultaneous pressing of the ↑ and ENTER keys produces an opening command.

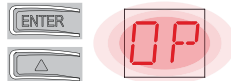

- The simultaneous pressing of the ↓ and ENTER keys produces a closing command.

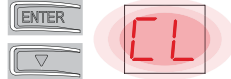

- The simultaneous pressing of the ↑ and ↓ keys produces a POWER RESET command (power supply interruption and automation restart).



- Keep the UP ↑ or DOWN ↓ key pressed to begin fast menu scrolling.
- In some menus, the parameter measurement unit can be viewed by pressing the ENTER key once the value has been displayed.

Example: setting of 10 seconds for parameter OB.



5.3 Menu map

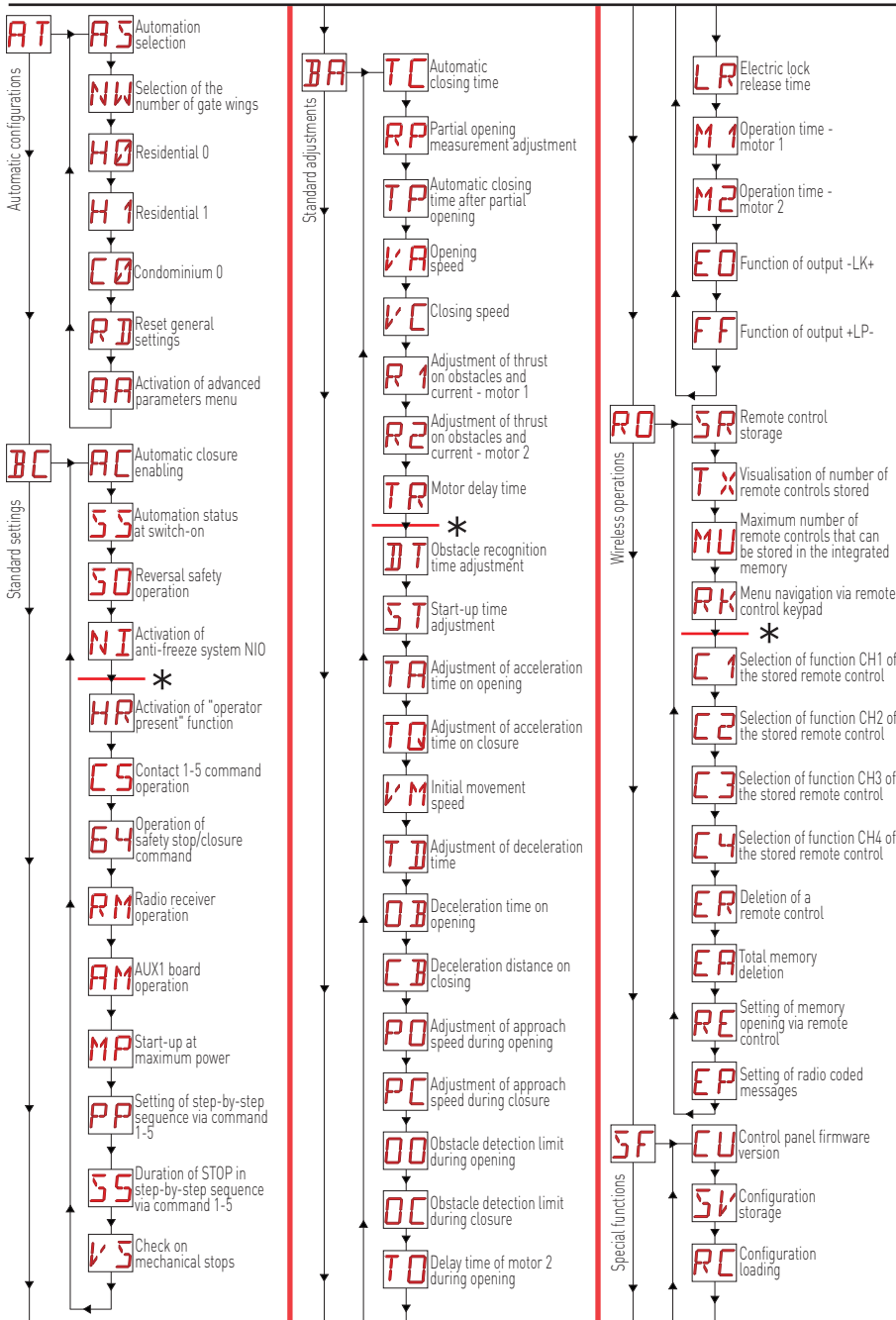

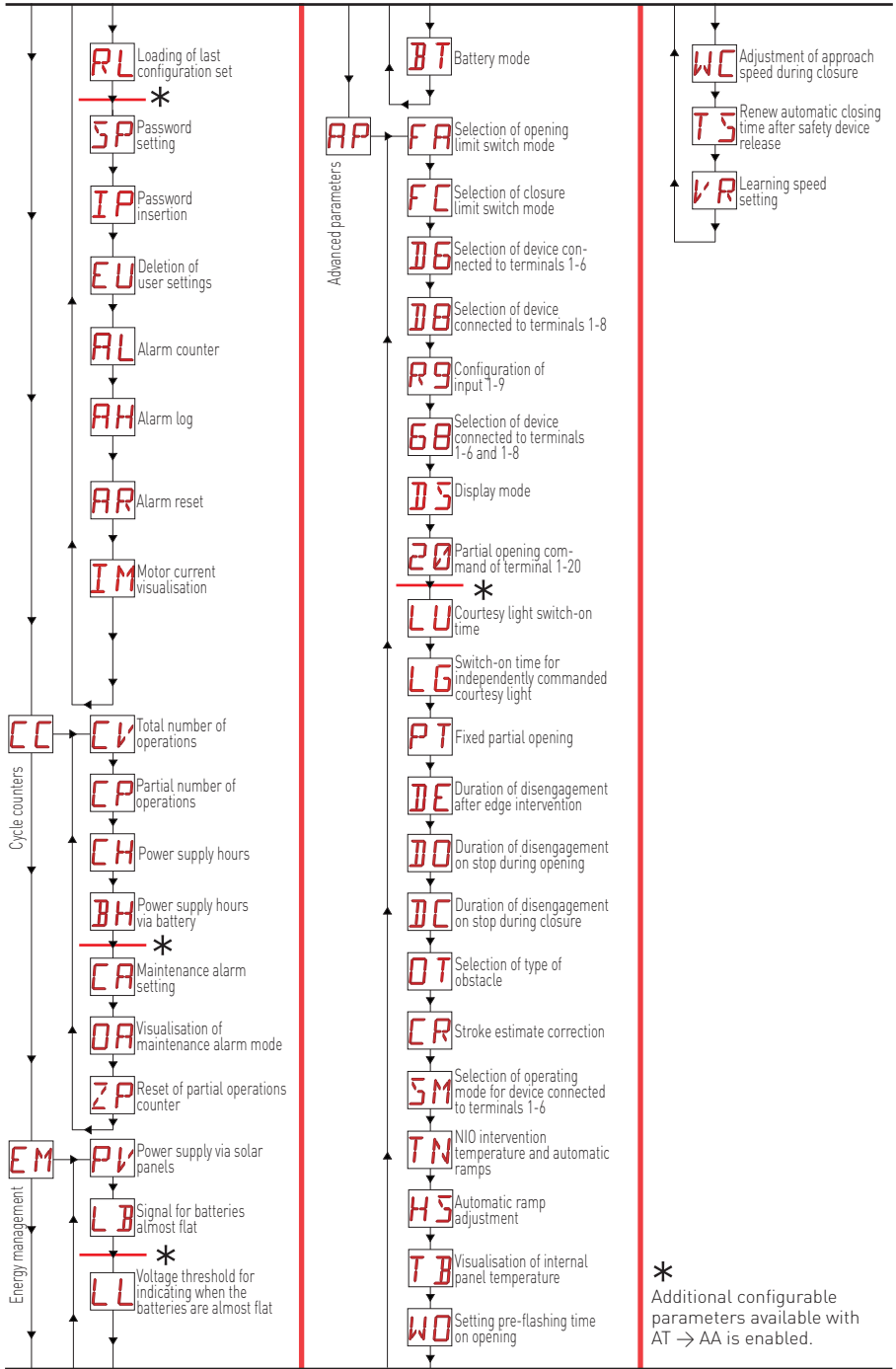

6. Quick start-up sequences

6.1 Selection of automation type

Example of Obbi automation selection

Set



Example of PWR25 automation selection

Set



NB: if no automation is selected (alarm **M0** active) using the   keys, you can access the values of parameter **AS** directly.

6.2 Configuration of the number of gate wings

Configuration example for a single gate wing

Set



6.3 Enabling the configurations

Step-by-step mode without automatic closure (residential use)



Step-by-step mode with automatic closure 1 min (residential use) [standard settings]



Opening mode with automatic closure 1 min (condominium use)



6.4 Adding remote controls



6.5 Configuration of the limit switches

Example 1 - Door wing stops against mechanical end stops (standard setting)

Set



Example 2 - Door wing stops against limit switches

Set



With these settings, if an obstacle is detected while opening, the door wing stops and performs a disengagement operation whereas during a closing operation, the door wing reopens.

Example 3 - Door wing stops against mechanical end stops and reverses motion if an obstacle is detected

Set



With these settings, the gate wing stops against its respective mechanical closing end stop and the opening limit switch.

If an obstacle is detected during the opening and before the activation of the stop limit switch, the gate wing stops with a disengagement operation.

If an obstacle is detected during closure and before the activation of the proximity limit switch, the gate wing reopens; once the proximity limit switch has been activated, the gate wing stops against the obstacle.

6.6 Configuration of the safety devices

Example 1 - Configuration of the photocells connected to terminals 1-8 and 1-6 [standard settings]

Set



Example 2 - Configuration of the safety edge with safety test simultaneously connected to terminals 1-6 and 1-8

Set



7. Application examples

7.1 Automations with two swinging gates

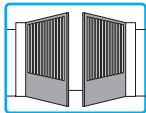

When the Entrematic LCU30H control panel is used in applications for automations with two overlapping swinging gate wings, the following connections can be made:

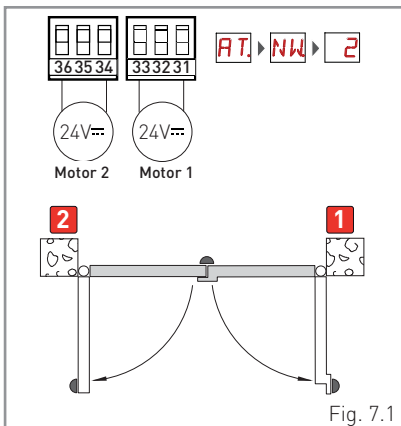

Fig. 7.1

(Fig. 7.1) Installation with mechanical end stops for opening and closure, and without the use of electric limit switches.

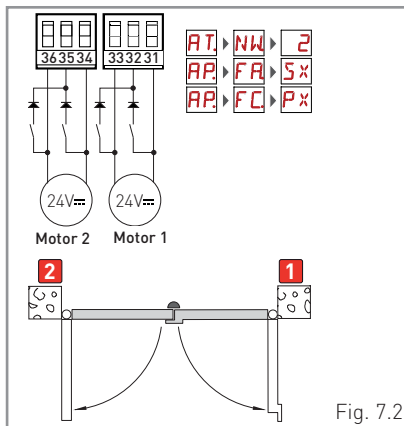
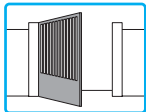

Fig. 7.2

(Fig. 7.2) Installation with mechanical end stop for closure, and with the use of electric limit switches (stop during opening and proximity during closure).

7.2 Automations with one swinging gate wing



When the Entrematic LCU30H control panel is used in applications for automations with one swinging gate wing, the following connections can be made:

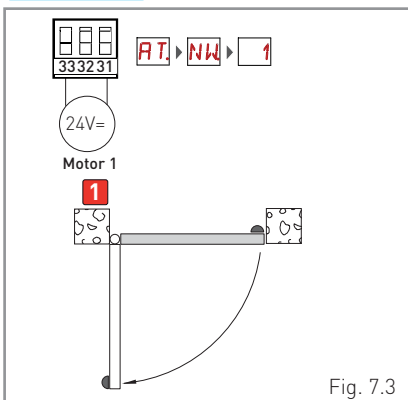

Fig. 7.3

(Fig. 7.3) Installation with mechanical end stops for opening and closure, and without the use of electric limit switches.

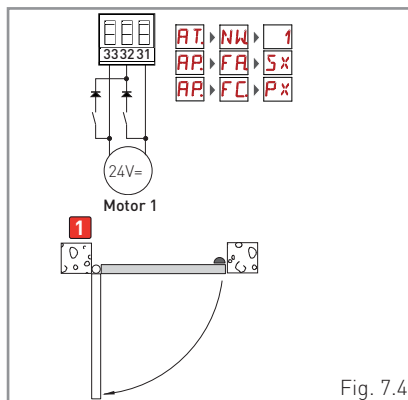

Fig. 7.4

(Fig. 7.4) Installation with mechanical end stop for closure, and with the use of electric limit switches (stop during opening and proximity during closure).

8. Commands





You are advised to read paragraph 11 for all the details about the possible adjustments.

Command	Function	Description
	STEP-BY-STEP	When selecting BC → CS → 1-5 , the closure of the contact activates a sequential opening or closing operation: opening-stop-closing-opening. WARNING: if automatic closure is enabled, the duration of the stop can be defined by selecting BC → SS . The "opening-stop-closing-opening" sequence can be changed to "opening-stop-closing-stop-opening" by selecting BC → PP .
	OPENING	When selecting BC → CS → 1-3 , the closure of the contact activates an opening operation.
	CLOSURE	When selecting BC → 64 → 1-4 , closing the contact activates a closing operation.
	SAFETY STOP	When selecting BC → 64 → 1-6 , opening of the safety contact stops and prevents any movement. NB: to set different safety contact functions, see the AP → SM parameter settings.
	CLOSING SAFETY DEVICE	The opening of the safety contact triggers a reversal of the movement (reopening) during the closing operation. When selecting BC → SO → ON , the opening of the contact prevents any operation when the automation is idle. When selecting BC → SO → OF , the opening of the contact only prevents closure when the automation is idle.
	CLOSING/ OPENING SAFETY DEVICE	The opening of the safety contact stops and prevents any movement. NB: operation corresponds to that of contact 1-6 with AP → SM → 05 .
	PARTIAL OPENING	The closure of the contact activates a partial opening operation. Once the automation stops, the partial opening control performs the opposite operation to the one performed before the stop.
	AUTOMATIC CLOSURE OR STOP	Selecting AP → 20 → 1-2 , the permanent closure of the contact enables automatic closure if AC → 1-2 . Selecting AP → 20 → 1-9 , the opening of the safety contact causes the movement to stop. NB: the flashing light flashes.







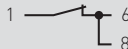

WARNING: make a jumper for all NC contacts if not used, or deactivate them via the relative menu. Terminals with the same number are equal.

8.1 SOFA1-SOFA2 or GOPAVRS self-controlled safety edge

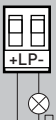
Command	Function	Description
	SAFETY TEST	Insert the SOFA1-SOFA2 or GOPAVRS device in the slot for plug-in boards AUX1 or AUX2. If the test fails, an alarm message appears on the display.
	NC	SAFETY STOP
	NC	CLOSURE SAFETY DEVICE
	NC	CLOSING/ OPENING SAFETY DEVICE

9. Outputs and accessories

Output	Value of accessories	Description
	24V $\overline{=}$ / 0.3A	Power supply to accessories . Output for power supply to external accessories. NB: the maximum absorption of 0.3A corresponds to the sum of all terminals 1. The gate open indicator light (1-13) is not calculated in the 0.3 A indicated above, the maximum value considered is 3 W.
	GOL148REA	If the GOL868R4 radio receiver is used (868.35 MHz), connect the supplied antenna wire (90mm).
	LAMPH 24V $\overline{=}$ / 25W	Flashing light. The pre-flashing settings can be selected from the third level menu AP \rightarrow WO and/or AP \rightarrow WC . To modify the operating mode of the LP output, refer to the selection BA \rightarrow FF .
	12V- / 15W	Electric lock It is activated when the operation begins with the automation closed. To modify the operating mode of the LK output, refer to the selection BA \rightarrow EO .
AUX	SOFA1-SOFA2 GOPAVRS LAN4S LAB9 BIXLR12 BIXLR22 GOL868R4 BIXLR42 LAN7S	The control panel has two slots for plug-in command and safety boards. The action of the control card can be defined by selecting BC \rightarrow AM . When using slot-in radio boards, remove the RDX module. The display will show RV . WARNING: the plug-in board must be inserted and removed with the power supply disconnected.

Output	Value of accessories	Description
<p>RDX</p> 	6ZENRS ZENPRS	<p>The control panel is fitted with a housing for modules of the 6ZENRS radio receiver type (433.92 MHz). Can be replaced with a radio receiver module of the ZENPRS type (868.35 MHz). The operating mode is selected via BC → RM. When using slot-in radio boards, remove the RDX module. The display will show RM. WARNING: the modules must be inserted and removed with the power supply disconnected.</p>
<p>COM</p> 	BIXM R2	<p>COM - This allows the functioning configurations to be saved using the function SF → SV. The saved configurations can be recalled using the function SF → RC.</p> <p>COM - The storage module allows the remote controls to be stored. If the control panel is replaced, the storage module being used can be inserted in the new control panel. WARNING: the storage module must be inserted and removed with the power supply disconnected, and paying attention to the positioning direction.</p>
<p>BAT</p> 	SBU	<p>BAT - Battery-powered operation. The batteries are kept charged when the power supply is on. If the power supply is off, the panel is powered by the batteries until the power is re-establish or until the battery voltage drops below the safety threshold. The control panel turns off in the last case. WARNING: the batteries must always be connected to the control panel for charging. Periodically check the efficiency of the batteries. NB: the operating temperature of the rechargeable batteries is from +5°C to +40°C. For advanced control of battery-powered operation, refer to the menu EM.</p>

10. Jumper setting

Jumper	Description	OFF	ON
JR1	Display mode selection.	<p>Display mode. Only the values and parameters present can be displayed.</p>	<p>Maintenance mode. Only the values and parameters present can be displayed and modified. Activated maintenance mode is indicated by the permanent switching on of the right-hand point on the display.</p>

11. Adjustments





NB: depending on the type of automation and control panel, some menus may not be available.

11.1 Main menu

Display	Description
AT	AT - Automatic Configurations. The menu allows you to manage the automatic configurations of the control panel.
BC	BC - Basic Configurations. The menu allows you to display and modify the main settings of the control panel.
BA	BA - Basic Adjustments. The menu allows you to display and modify the main adjustments of the control panel. NB: some settings require at least three operations before they are set correctly.
RO	RO - Radio Operations. The menu is used to manage the radio functions of the control panel (alarm management, diagnostics enabling, FW updating).
SF	SF - Special Functions. The menu allows you to set the password and manage the special functions in the control panel.
CC	CC - Cycles Counter. The menu allows you to display the number of operations carried out by the automation and manage the maintenance interventions.
EM	EM - Energy Management. The menu allows you to display and modify the energy saving settings and adjustments (Green Mode and battery management).
AP	AP - Advanced Parameters. The menu allows you to display and modify the advanced settings and adjustments of the control panel (limit switch mode, selection of devices connected to the terminals, disengagement duration adjustments, flashing light adjustments, etc.). NB: some settings require at least three operations before they are set correctly.

From the main menu you can access the second level menu as follows:

- use the  and  keys to select the required function
- press  to confirm



After confirming the selection, you access the second level menu.

For each function of the main menu, there are also additional configurations that can be viewed by enabling the **AA** function (see the following paragraph).



NB: to check if the parameters have actually been modified, quit the relative parameter and then access it again.
The modifications will take effect from the next operation.

11.2 Second level menu - AT (Automatic Configurations)

AT - Automatic configurations	Display	Description	Selections available	
	AS	AS - Automation selection This selection pre-sets the type of motor and a sub-set of parameters linked to the kinematic mechanism of the automation for a standard installation. See "Selection of automation type", paragraph 11.2.1. Each parameter can still be modified when necessary.	N007	
NW	NW - Selection of the number of gate wings In the case of automations with a single gate wing, connect motor 1.	0 1 0 2		
H0	H0 - Predefined setting, residential use 0 This selection loads predefined values for certain standard parameters: AC - enabling of automatic closing : 1-2 C5 - step-by-step/opening command operation : Step-by-step RM - remote control operation : Step-by-step AM - AUX plug-in board operation : Step-by-step SS - Selection of automation status at start-up : open			
H1	H1 - Predefined setting, residential use 1 This selection loads predefined values for certain standard parameters: AC - enabling of automatic closing : enabled TC - setting of automatic closing time : 1 minute C5 - step-by-step/opening command operation : Step-by-step RM - remote control operation : Step-by-step AM - AUX plug-in board operation : Step-by-step SS - Selection of automation status at start-up : closed			
C0	C0 - Predefined setting, condominium use 0 This selection loads predefined values for certain standard parameters: AC - Enabling of automatic closure : enabled TC - setting of automatic closing time : 1 minute C5 - step-by-step/opening command operation : Opening RM - remote control operation : Opening AM - AUX plug-in board operation : Opening SS - Selection of automation status at start-up : closed			
RD	RD - Resetting of general settings (SETTINGS RESET)  ⌀2" ⌀2"			
AA	AA - Activation of additional configurable parameters for each function of the main menu.  ⌀2"	AA	AA	AA
	After activation you can scroll through the third level menus. The third level menus are activated for 30 min.			

11.2.1 Selection of automation type **AT** → **AS** and specific default settings

AS Type of automation	Model	R1-R2 Thrust on obstacles and current	VA - VC Speed during opening and closure	VR Learning speed	PO-PC Ap-proach speed	TA Accel-eration time during opening	TQ Accel-eration time during closure	VM Ramp start-up speed
01	OBBI3BH	50	24	18	07	2	3	03
02	ARCBH	70	14	10	06	2	3	03
03	FACIL3H	50	12	10	05	2	3	03
04	LUX03BH-4BH	40	16	12	06	1	2	10
05	PWR25H	50	18	10	05	2	3	03
06	PWR35H	50	20	12	06	2	3	03
07	PWR40H	40	22	15	06	1	2	10

11.3 Second level menu - BC (Basic Configurations)

Display	Description	Selections available
BC - Basic configurations	AC - Enabling of automatic closure ON - Enabled 1-2 - Dependent on input 1-2	ON1-2 <u> </u>
	SS - Selection of automation status at start OP - Open CL - Closed Indicates how the control panel considers the automation at the time of switch-on, or after a POWER RESET command.	OPCL <u> </u>
	SO - Enabling of reversal safety contact functioning ON - Enabled OF - Disabled When enabled (ON) with the automation idle, if the contact 1-8 is open, all operations are prevented. When disabled (OF) with the automation idle, if the contact 1-8 is open, opening operations are permitted.	ON <u> </u> OF <u> </u>
	NI - Enabling of NIO electronic anti-freeze system ON - Enabled OF - Disabled When enabled (ON), it maintains the efficiency of the motor even at low ambient temperatures. NB: for correct operation, the control panel must be exposed to the same ambient temperature as the motors. The intervention temperature for NIO can be set by selecting AP → TN .	ON <u> </u> OF <u> </u>

11.3.1 Additional BC level parameters that can be configured (available with **AT** → **AA** enabled)

BC	Display	Description	Selections available	
	HR	HR - Enabling of "operator present" function ON - Enabled OF - Disabled NB: Set HR → ON only if 64 → 1-4 and C5 → 1-3 .	ON	<u>OF</u>
	C5	C5 - Operation of command associated with contact 1-5 1-5 - Step-by-step 1-3 - Opening	<u>1-5</u>	1-3
	64	64 - Functioning of safety stop/closing command. 1-4 - Closing 1-6 - Safety stop	1-4	<u>1-6</u>
	RM	RM - Radio receiver operation 1-5 - Step-by-step 1-3 - Opening	<u>1-5</u>	1-3
	AM	AM - Operation of AUX1 plug-in control board 1-5 - Step-by-step 1-3 - Opening	<u>1-5</u>	1-3
	MP	MP - Start-up at maximum power ON - During start-up it increases the thrust on obstacles to maximum OFF - During start-up, the thrust on obstacles is the one adjusted by R 1-R2 .	<u>ON</u>	OF
	PP	PP - Setting step-by-step sequence from command 1-5. ON - Opening-Stop-Closing-Stop-Opening OF - Opening-Stop-Closing-Opening	ON	<u>OF</u>
	S5	S5 - Duration of STOP in step-by-step sequence from command 1-5. ON - Permanent OF - Temporary	ON	<u>OF</u>
	V5	VS - Checking the mechanical end stops When enabled (ON), every time the power supply is connected the automation automatically checks the mechanical stops and/or stop limit switches during opening and closing at the speed set with the adjustment AP → V.R . During the learning operation, the display shows the message MQ and the closing operation involves one gate wing at a time (1C).	<u>ON</u>	OF

11.4 Second level menu - BA (Basic Adjustment)

Display	Description	Selections available
TC	TC - Setting of automatic closing time [s] It is set with different intervals of sensitivity. <ul style="list-style-type: none"> from 0" to 59" with intervals of 1 second from 1' to 2' with intervals of 10 seconds 	00 59 1' 2' 1'00"
RP	RP - Adjustment of partial opening measurement [%] Adjusts the percentage of operation in relation to the total opening of the automation. Partial opening is performed on gate wing 1. 10 - Minimum 99 - Maximum	10 99 50
TP	TP - Setting of automatic closing time after partial opening [s] It is set with different intervals of sensitivity. <ul style="list-style-type: none"> from 0" to 59" with intervals of 1 second from 1' to 2' with intervals of 10 seconds 	00 59 1' 2' 30
VA	VA - Opening speed [V]	04 27 See paragraph 11.2.1
VC	VC - Closing speed [V]	04 27 See paragraph 11.2.1
R1	R1 - Adjustment of thrust on obstacles and current - motor 1 [%] The control panel is fitted with a safety device which, when it detects an obstacle: <ul style="list-style-type: none"> stops the opening movement and, if outside the limit area for detecting obstacles, performs a disengagement operation whose duration can be set with AP → JE; reverses the movement during closure operations outside the limit area for detecting obstacles; stops the movement during closure operations within the limit area for detecting obstacles. The limit area for detecting obstacles during opening and closing is determined by the type of limit switch installed. If there is no limit switch, it is determined on the basis of the selections BA → 00 and BA → 0C . 00 - Minimum thrust 99 - Maximum thrust	00 99 See paragraph 11.2.1

BA - Basic adjustment

BA - Basic adjustment

Display	Description	Selections available
R2	<p>R2 - Adjustment of thrust on obstacles and current - motor 2 [%] The control panel is fitted with a safety device which, when it detects an obstacle:</p> <ul style="list-style-type: none"> - stops the opening movement and, if outside the limit area for detecting obstacles, performs a disengagement operation whose duration can be set with AP → DE; - reverses the movement during closure operations outside the limit area for detecting obstacles; - stops the movement during closure operations within the limit area for detecting obstacles. <p>The limit area for detecting obstacles during opening and closing is determined by the type of limit switch installed. If there is no limit switch, it is determined on the basis of the selections BA → 00 and BA → 0C. 00 - Minimum thrust 99 - Maximum thrust</p>	<p>00 ▶ 99 See paragraph 11.2.1</p>
TR	<p>TR - Motor delay time [s] Delay time for closure of gate wing 1 in relation to gate wing 2. 00-30 s</p>	<p>00 ▶ 30 10</p>







NB: make adjustments gradually and only after performing at least three complete operations to allow the control panel to be set correctly and detect any friction during operations.

11.4.1 Additional BA level parameters that can be configured (available with **AT** → **AA** enabled)

Display	Description	Selections available
DT	<p>DT - Adjustment of obstacle recognition time [s/100] 10 - Minimum 60 - Maximum NB: the parameter is adjusted in hundredths of a second.</p>	<p>10 ▶ 60 20</p>
ST	<p>ST - Adjustment of start time [s] 0.5 - Minimum 3.0 - Maximum</p>	<p>0.5 ▶ 3.0 2.0</p>
TA	<p>TA - Adjustment of acceleration time during opening [s] 0.5 - Minimum 9.9 - Maximum</p>	<p>0.5 ▶ 9.9 See paragraph 11.2.1</p>
TQ	<p>TQ - Adjustment of acceleration time during closure [s] 0.5 - Minimum 9.9 - Maximum</p>	<p>0.5 ▶ 9.9 See paragraph 11.2.1</p>
VM	<p>VM - Initial movement speed [V] 00 - Minimum 15 - Maximum [See paragraph 11.2.1]</p>	<p>00 ▶ 15</p>



Display	Description	Selections available
TD	TD - Adjustment of deceleration time [%] Adjusts the deceleration ramp slope 10 - Minimum 99 - Maximum	10 ▶ 99 <u>50</u>
OB	OB - Setting of deceleration time during opening [s] Indicates the time between the start of the deceleration ramp and the end of the opening stroke 00 - Minimum 30 - Maximum	00 ▶ 30 <u>10</u>
CB	CB - Setting of deceleration time during closing [s] Indicates the time between the start of the deceleration ramp and the end of the opening stroke 00 - Minimum 30 - Maximum	00 ▶ 30 <u>10</u>
PO	PO - Adjustment of approach speed during opening [V] Indicates the speed from the end of the deceleration ramp to the end of the opening stroke 03 - Minimum 10 - Maximum NB: gradually increase the approach speed if there is a series of quick vibrations (chattering) in heavy gates installed with a slight incline.	03 ▶ 10 See paragraph 11.2.1
PC	PC - Adjustment of approach speed during closing [V] Indicates the speed from the end of the deceleration ramp to the end of the closing stroke. 03 - Minimum 10 - Maximum	03 ▶ 10 See paragraph 11.2.1
OO	OO - Obstacle detection limit during opening [%] Indicates the percentage of the distance travelled during BA → OB or after the detection of the opening limit switch AP → FA → RA on which the disengagement is deactivated. NB: not active if AP → FA → Sx or if AP → FA → Px .	05 ▶ 99 <u>99</u>
OC	OC - Obstacle detection limit during closure [%] Indicates the percentage of the distance travelled during BA → CB or after the detection of the closing limit switch AP → FC → RA on which the reversal is deactivated. NB: not active if AP → FC → Sx and if AP → FC → Px .	05 ▶ 99 <u>99</u>
TO	TO - Setting motor 2 opening delay time [s] Adjustment, in seconds, of the delay time for starting the operation of motor 2, in relation to motor 1.	00 ▶ 30 <u>03</u>
LR	LR - Electric lock release time [s] If enabled, this indicates the electric lock activation time at the start of every opening operation with the automation closed.	0.5 ▶ 2.5 <u>1.5</u>
M 1	M1 - Operation time - motor 1 [s] Adjustment, in seconds, of the total operation time for motor 1.  WARNING: it is set with a sensitivity interval of 0.5 s, shown when the decimal point on the right lights up. Example: 07 = 7 seconds / 07 = 7.5 seconds NB: the setting of M 1 is only active with BC → V5 → OF .	02 ▶ 60 <u>10</u>

Display	Description	Selections available
M2	<p>M2 - Operation time - motor 2 [s] Adjustment, in seconds, of the total operation time for motor 1.</p> <p> WARNING: it is set with a sensitivity interval of 0.5 s, shown when the decimal point on the right lights up.</p> <p>Example:  = 7 seconds /  = 7.5 seconds</p> <p>NB: the setting of M2 is only active with BC → V5 → OF.</p>	 
EO	<p>EO - Function of output -LK+</p> <ul style="list-style-type: none"> 00 - courtesy light <u>01</u> - electric lock 02 - electric lock + release stroke 03 - ON-OFF flashing light 04 - ON-OFF flashing light for LED without oscillator 05 - fixed light with internal oscillator 06 - proportional indicator light for open gate (with signal of battery operation) 07 - fixed indicator light for open gate (automation not closed) 08 - automation closed (for fail-safe electromagnets) 09 - automation open 10 - automation moving (can also be used for electromagnets that need to be powered throughout the operation) 11 - automation opening 12 - automation closing 13 - maintenance alarm 14 - signal for batteries almost flat ON - output always active 	
FF	<p>FF - Function of output +LP-</p> <ul style="list-style-type: none"> 00 - courtesy light 01 - electric lock 02 - electric lock + release stroke <u>03</u> - ON-OFF flashing light 04 - ON-OFF flashing light for LED without oscillator 05 - fixed light with internal oscillator 06 - proportional indicator light for open gate (with signal of battery operation) 07 - fixed indicator light for open gate (automation not closed) 08 - automation closed (for fail-safe electromagnets) 09 - automation open 10 - automation moving (can also be used for electromagnets that need to be powered throughout the operation) 11 - automation opening 12 - automation closing 13 - maintenance alarm 14 - signal for batteries almost flat ON - output always active 	

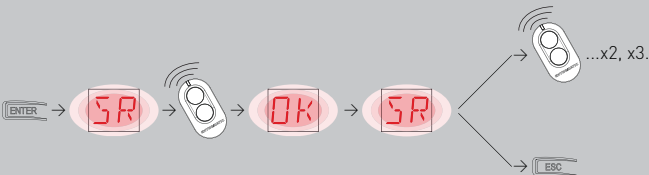

NB: make adjustments gradually and only after performing at least three complete operations to allow the control panel to be set correctly and detect any friction during operations.

11.5 Second level menu - RO (Radio Operations)

RO - Radio operations	Display	Description	
	SR	<p>SR - Remote control storage</p> <p>You can directly access the Remote control storage menu even with the display turned off, but only with the Display visualisation mode option set to 00 or 03:</p> <ul style="list-style-type: none"> - for transmitting a remote control not present in the memory; - for transmitting an unstored channel of a remote control already present in the memory.  <p>WARNING: if the display shows NO flashing, the remote control may already be stored.</p>	
	TX	<p>TX - Visualisation of counter showing remote controls stored</p> <p>ENTER → 00 → 16 → 16 remote controls (example)</p>	
MU	<p>MU - Indication of maximum number of remote controls that can be stored in the integrated memory</p> <p>You can store a maximum of 100 or 200 remote control codes.</p>  <p>20 - 200 remote controls that can be stored 10 - 100 remote controls that can be stored</p>	<p>Selections available</p> <p style="font-size: 2em; color: red;">20 10</p> <hr style="width: 50%; margin: 0 auto;"/>	

! **WARNING:** selecting **MU** → **20** (200 remote controls), the configurations **U 1** and **U 2** saved with the **SF** → **SV** command will be lost. This also applies for the last configuration reloaded with **RL**. In addition, new configurations cannot be saved on **U 1** and **U 2**.

R0 - Radio operations

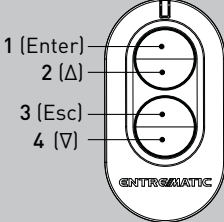
Display	Description	Selections available
RK	<p>RK - Menu navigation using remote control keyboard ON - Enabled OF - Disabled</p> <p>With the display turned off, quickly type in the sequence of keys 3 3 2 4 1 from the stored remote control you want to use. Make sure all the CH keys are stored. WARNING: during navigation with a remote control keyboard ALL the stored remote controls are inactive.</p>  <p>1 (Enter) 2 (Δ) 3 (Esc) 4 (∇)</p> <p>To make viewing and adjustment easier (avoiding the need to continuously press the remote control), press the UP ↑ or DOWN ↓ key once to begin slowly scrolling through the parameters. This scrolling movement is faster if the UP ↑ or DOWN ↓ key is pressed twice. To stop the scrolling, press ENTER. To confirm your choice of parameter, press ENTER again. To test any new setting, switch off the display and issue an opening command using key 3. Navigation using a remote control keyboard is automatically disabled after 4 minutes of inactivity or by setting RK → OF.</p>	<p>ON</p> <p>OF</p>

11.5.1 Additional B0 level parameters that can be configured (available with **AT** → **AA** enabled)

Display	Description	Selections available
R0	<p>C1, C2, C3, C4 - Selection of CH1, CH2, CH3, CH4 function of stored remote control. NO - No setting selected 1-3 - Opening command 1-4 - Closing command 1-5 - Step-by-step command P3 - Partial opening command LG - Command to switch the courtesy light on/off 1-9 - STOP command</p> <p>If even just one (any) CH key of the remote control is stored, the opening or step-by-step command is implemented. NB: the 1-3 (opening) and 1-5 (step-by-step) options are available as alternatives, and depend on the selection BC → RM. If 2-4 CH keys of a single remote control are stored, the functions matched in the factory with the CH keys are as follows:</p> <ul style="list-style-type: none"> • CH1 = opening/step-by-step command • CH2 = partial opening command; • CH3 = courtesy light on/off command • CH4 = STOP command. 	<p>NO</p> <p>1-3</p> <p>1-4</p> <p>1-5</p> <p>P3</p> <p>LG</p> <p>1-9</p>

Display	Description	Selections available
RO	ER - Deletion of a single remote control 	
	EA - Total memory deletion 	
	RE - Setting memory opening from remote control OF - Disabled ON - Enabled When enabled (ON), the remote programming is activated. To store new remote controls without using the control panel, refer to the remote control instructions. NB: make sure you do not accidentally memorise unwanted remote controls.	ON OF
	EP - Setting the coded area messages If the possibility to receive coded messages is enabled, the control panel will be compatible with remote controls of the "ENCRYPTED" type.	ON OF

11.6 Second level menu - SF (Special Functions)







Display	Description	Selections available
SF - Special Functions	CU - Visualisation of the firmware version on the control panel 	
	SV - Saving user configuration on control panel storage module. <p>By selecting RO → MU → 10 you can save up to 2 personalised configurations in memory positions U1 and U2 only with the storage module present on the control panel.</p> <p>WARNING: if RO → MU → 20 is selected, no user configuration can be saved on U1 and U2.</p> <p>WARNING: if the display visualises NO flashing, the memory module may not be installed.</p>	U1 U2
	RC - Configuration loading <p>It's possible to load the user configurations previously stored U1 and U2 on the memory module of the control panel.</p>	U1 U2

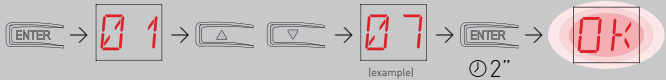
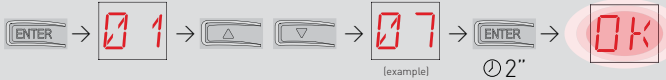

SF - Special Functions

Display	Description
RL	<p>RL - Loading of last configuration set</p>  <p>The control panel automatically saves the last configuration set, and keeps it memorised in the storage module. In the event of a fault or the replacement of the control panel, the last configuration of the automation can be restored by inserting the storage module and loading the last configuration set.</p>

















11.6.1 Additional SF level parameters that can be configured (available with AT → AA enabled)

SF



Display	Description
SP	<p>SP - Setting the password</p>  <p>NB: this can only be selected when the password is not set. Setting the password prevents unauthorised personnel from accessing selections and adjustments. You can delete the set password by selecting the sequence JR1=ON, JR1=OFF, JR1=ON.</p>
IP	<p>IP - Inserting the password</p>  <p>NB: this can only be selected when the password is set. When the password is not inserted, you can access the display mode regardless of the selection made with JR1. When the password is inserted, you can access in maintenance mode.</p>
EU	<p>EU - Deletion of user configurations and last configuration set in the storage module</p> 
AL	<p>AL - Alarm counter</p> <p>Used to view, in sequence, the counters of alarms that have been triggered at least once (alarm code + number of times triggered). With  and  you can scroll through all the counters and see all the alarms recorded.</p>
AH	<p>AH - Alarm log</p> <p>Used to view, in sequence, alarms that have been triggered (maximum 20). With  and  you can scroll through the entire alarm log. The display shows the alarm number and code, alternated. The highest number corresponds to the most recent alarm and the lowest number (0) corresponds to the oldest alarm.</p>

Display	Description
SF AR	AR - Alarm reset Resets all the alarms in the memory (counters and log).  →  ⊙2" NB: when the installation has been completed, you are advised to delete the alarms in order to facilitate future checks.
	IM - Motor current visualisation Selecting M1 , the display will show the current absorbed by motor 1. Selecting M2 , the display will show the current absorbed by motor 2.



11.7 Second level menu - CC (Cycles Counter)

Display	Description
CC - Cycle Counter CV	CV - Display of total operations counter  →  →  →  → 182 operations (example)
	CP - Display of partial operations counter  →  →  →  → 716 operations (example)
	CH - Display of power supply hour counter  →  →  →  → 215 operating hours via battery (example)
	BH - Visualisation of counter for power supply hours via battery  →  →  →  → 215 operating hours via battery (example)

11.7.1 Additional CC level parameters that can be configured (available with **AT** → **AA** enabled)

Display	Description	Selections available
CC CA	CA - Setting the maintenance alarm (factory setting - alarm deactivated: 0.0 00. 00). You can set the required number of operations (regarding the partial operations counter) for signalling the maintenance alarm. When the set number of operations is reached, the alarm message appears on the display V 0 . Example: Setting the maintenance alarm after 700 operations (00) (07) (00) 	
	OA - Selecting maintenance alarm display mode 00 - Visualisation on display (alarm message V 0) 01 - Visualisation on flashing light (with the automation idle, 4 flashes are made and then repeated every hour) and on display (alarm message V 0). 02 - Visualisation on "open gate" indicator light (with the automation closed, 4 flashes are made and then repeated every hour) and on display (alarm message V 0).	
	ZP - Reset of partial operations counter  02" For correct functioning, you are advised to reset the partial operations counter: - after maintenance work; - after setting the maintenance alarm interval.	

11.8 Second level menu - EM (Energy Management)

Display	Description	Selections available
EM - Energy Management PV	PV - Solar panel power supply (panels not supplied) ON - Enabled OF - Disabled	
	LB - Indication that batteries are almost flat 00 - Visualisation on display (alarm message B 0) 01 - Visualisation on flashing light (with the automation idle, 2 flashes are made and then repeated every hour) and on display (alarm message B 0) 02 - Visualisation on "open gate" indicator light (with the automation closed, 2 flashes are made and then repeated every hour) and on display (alarm message B 0)	

11.8.1 Additional EM level parameters that can be configured (available with **AT** → **AA** enabled)

Display	Description	Selections available
EM	LL - Voltage threshold for indicating that batteries are almost flat (V) 17 - Minimum 24 - Maximum NB: it is set with an interval of sensitivity of 0.5 V shown when the decimal point on the right lights up.	
	BT - Battery mode 00 - Anti-panic (performs the opening operation following a mains supply failure. The automation opens but does not accept any other commands until the mains supply has been restored). 01 - Continuous operation - the last operation performed before control panel switch-off will be an opening. 02 - Continuous operation - the last operation performed before control panel switch-off will be an closure.	

11.9 Second level menu - AP (Advanced Parameters)

Display	Description	Selections available
AP - Advanced Parameters	FA - Selection of opening limit switch mode NO - None SX - Stop limit switch (after activation, the gate wing stops its movement) PX - Proximity limit switch (after activation, the gate wing continues as far as the end stop and any obstacle is considered a stop) RA - Deceleration limit switch (after activation, the gate wing slows down its movement)	
	FC - Selection of closing limit switch mode NO - None SX - Stop limit switch (after activation, the gate wing stops its movement) PX - Proximity limit switch (after activation, the gate wing continues as far as the end stop and any obstacle is considered a stop) RA - Deceleration limit switch (after activation, the gate wing slows down its movement)	
	D6 - Selection of device connected to terminals 1-6 NO - None SE - Safety edge (if contact 1-6 opens, there is a disengagement of 10cm after the stop) S41 - Safety edge with safety test (if contact 1-6 opens, after the stop there is a disengagement of a duration depending on the selection AP → JE) PH - Photocells P41 - Photocells with safety test	
	D8 - Selection of device connected to terminals 1-8 NO - None SE - Safety edge S41 - Safety edge with safety test PH - Photocells P41 - Photocells with safety test	

AP - Advanced Parameters

Display	Description	Selections available
R9	R9 - Enabling automatic closing after command 1-9 via radio (STOP). ON - Enabled OF - Disabled When enabled (ON), after a command 1-9 via radio, the automation carries out automatic closing (if enabled), after the set time.	ON OF
68	68 - Selection of the device simultaneously connected to terminals 1-6 and 1-8 N0 - None SE - Safety edge S41 - Safety edge with safety test If different from N0, the simultaneous opening of inputs 1-6 and 1-8 causes: - movement stop and reversal during a closing operation - movement stop and disengagement of a duration depending on the selection AP → DE during an opening operation	N0 SE S41
DS	DS - Setting of display visualisation mode 00 - No visualisation 01 - Commands and safety devices with radio test (see paragraph 9.2) Display of count down to automatic closing 02 - Automation status (see paragraph 12.1) 03 - Commands and safety devices (see paragraph 12.2) NB: the setting 01 allows you to see when a radio transmission is received, for range checks.	00 01 02 03



NB: make adjustments gradually and only after performing at least three complete operations to allow the control panel to be set correctly and detect any friction during operations.

11.9.1 Additional AP level parameters that can be configured (available with **AT** → **AA** enabled)

Display	Description	Selections available
20	20 - Partial opening command of terminal 1-20 P3 - Partial opening command 1-2 - Enabling of automatic closure 1-9 - Stop input	P3 1-2 1-9

Display	Description	Selections available
LU	<p>LU - Setting the courtesy light switch-on time (s) To enable this parameter, set at least one of the selections $BA \rightarrow EO$ or $BA \rightarrow FF$ as a courtesy light. It is set with different intervals of sensitivity.</p> <p>NO - Disabled - from 01" to 59" with intervals of 1 second - from 1' to 2' with intervals of 10 seconds - from 2' to 3' with intervals of 1 minute ON - Permanently enabled (switched off via remote control) NB: the courtesy light switches on at the start of each operation.</p>	<p>NO 0 1 5 9 1' 2' 2' 3' ON</p>
LG	<p>LG - Switch-on time for independently commanded courtesy light [s] To enable this parameter, set at least one of the selections $BA \rightarrow EO$ or $BA \rightarrow FF$ as a courtesy light. It is set with different intervals of sensitivity.</p> <p>NO - Disabled - from 01" to 59" with intervals of 1 second - from 1' to 2' with intervals of 10 seconds - from 2' to 3' with intervals of 1 minute ON - Switched on and off with remote control NB: the switching on of the light does not depend on the start of an operation, but can be commanded separately using the special remote control key.</p>	<p>NO 0 1 5 9 1' 2' 2' 3' ON</p>
PT	<p>PT - Fixed partial opening ON - Enabled OF - Disabled If ON, a partial opening command given on the partial opening position is ignored. With contact 1-20 closed (for example with the timer or manual selector), the gate will partially open. If it is then fully opened (command 1-3) and reclosed (even with automatic closure), it will stop at the partial opening position.</p>	<p>ON OF</p>
DE	<p>DE - Disengagement duration if an edge is triggered [s] Regulates the duration of the disengagement when an edge (active or passive) is triggered during opening or closure. In the case of gates with two wings, it acts on both wings. 00 - Deactivated</p>	<p>0.0 2.0 1.0</p>
DO	<p>DO - Duration of disengagement on stop during opening [s/100] Regulates the duration of the disengagement on the mechanical opening stop. 00 - Disabled 99 - Maximum NB: not active if $FA \rightarrow SX$</p>	<p>00 99</p>
DC	<p>DC - Duration of disengagement on stop during closure [s/100] Regulates the duration of the disengagement on the mechanical opening stop. 00 - Disabled 99 - Maximum NB: not active if $FC \rightarrow SX$</p>	<p>00 99</p>
OT	<p>OT - Selection of type of obstacle 00 - Overcurrent or gate stopped 01 - Overcurrent 02 - Door stopped</p>	<p>00 0 1 02 0 1</p>

Display	Description	Selections available
CR	CR - Stroke estimate correction [%] DO NOT USE (diagnostic purposes only)	-- 9 ▶ + 9
SM	SM - Selection of operating mode of device connected to terminals 1-6 00 - During the operation, the opening of the safety contact stops the movement (with disengagement if DB → SE / S4). 01 - During the operation, the opening of the safety contact stops the movement (with disengagement if DB → SE / S4). When the contact closes again, the operation is resumed. 02 - During the operation, the opening of the safety contact stops the movement (with disengagement if DB → SE / S4). When the contact closes again, an opening operation is performed. 03 - During the closing operation, the opening of the safety contact reverses the movement. During the opening operation, the safety device is ignored. 04 - During the opening operation, the opening of the safety contact stops the movement (with disengagement if DB → SE / S4). When the contact closes again, the interrupted opening operation is resumed. During the closing operation, the safety device is ignored. 05 - During the closing operation, the opening of the safety contact stops and reverses the movement. During the opening operation, the opening of the safety contact stops the movement (with disengagement if DB → SE / S4).	000 1 020 3 040 5
TN	TN - Setting of intervention temperature for NIO electronic anti-freeze system and automatic HS ramps [°C] This value does not refer to the ambient temperature, but to the internal control panel temperature.	-- 9 ▶ 50 20
HS	HS - Automatic ramp adjustment ON - Enabled OF - Disabled When enabled (ON), at low ambient temperatures the start time ST increases up to the maximum value and the acceleration time TA and TQ diminishes to the minimum value. NB: for correct operation, the control panel must be exposed to the same ambient temperature as the motors. The intervention temperature can be set with the selection AP → TN .	ON OF
TB	TB - Permanent display of the internal control panel temperature [°C]	ON OF
WO	WO - Setting of pre-flashing time on opening [s] Adjustment of the lead time for the switch-on of the flashing light, in relation to the start of the opening operation from a voluntary command. 00 - Minimum 05 - Maximum	000 ▶ 05 00
WC	WC - Setting of pre-flashing time on closing [s] Adjustment of the lead time for the switch-on of the flashing light, in relation to the start of the closing operation from a voluntary command. 00 - Minimum 05 - Maximum	000 ▶ 05 00"

AP

AP	Display	Description	Selections available
	TS	TS - Setting of renewal of automatic closing time after safety device release [%] 00 - Minimum 99 - Maximum	00 99 99
VR	VR - Setting of learning speed [V]	04 20 See paragraph 11.2.1	

12. Signals visualised on the display

i NB: depending on the type of automation and control panel, certain visualisations may not be available.

12.1 Display of automation status

i NB: the automation status display mode is only visible with Display visualisation mode set to 02.

AP ▶ TS ▶ 02

Display	Description	Display	Description
	Automation closed		Automation opening
	Automation open		Automation closing, from partial opening
	Automation stopped in intermediate position		Automation in partial opening
	Automation closing		Automation partially open

12.2 Display of safety devices and commands

i NB: the safety device and command display mode is only visible with Display visualisation mode set at 01 or 03.

AP ▶ TS ▶ 01 AP ▶ TS ▶ 03

Display	Description	Display	Description
1-2	1-2 - Automatic closing activation command	1-6	1-6 - Safety device with opening and closing stop

Display	Description	Display	Description
1-3	1-3 - Opening command	S1	S1. - Detection of stop during closure - motor 1
1-4	1-4 - Closing command	S.1	S.1. - Detection of stop during closure - motor 2
1-5	1-5 - Step-by-step command	1-8	1-8 - Safety with closing reversal
P3	P3 - Partial opening command.	1-9	1-9 - STOP command
3P	3P - Opening command with operator present	68	68 - Partial opening command
4P	4P - Closing command with operator present	S2.	S2. - Detection of stop during opening - motor 1
R X	RX - Radio reception (of any memo-rised key of a transmitter present in the memory)	S.2.	S.2. - Detection of stop during opening - motor 2
N X	NX - Radio reception (of any non-mem- orised key)	00.	00. - Reaching of obstacle detection limit during opening - motor 1
	NB: with the selection AP → DS → 0 1 , it is also visualised when a command is received from a non-stored transmitter.	0.0.	0.0. - Reaching of obstacle detection limit during opening - motor 2
E X	EX - Rolling-code radio reception out of sequence	0C.	0C. - Reaching of obstacle detection limit during closing - motor 1
EP	EP - Radio reception not complying with the parameter configuration RO → EP	0.C.	0.C. - Reaching of obstacle detection limit during closing - motor 2
C X	CX - Command received from AUX1 board	RV	RV - Enabling/disabling of built-in radio receiver via RDX
F.C.	F.C. - Closure limit switch - motor 1	MQ	MQ - Learning operation of mechanical end stops in progress
F.C.	F.C. - Closure limit switch - motor 2	HT	HT - Heating of the motors (NIO function) in progress
F.A.	F.A. - Opening limit switch - motor 1	J 1	JR1 - Variation of the JR1 jumper status
F.A.	F.A. - Opening limit switch - motor 2	1C	1C - Closing operation (1 gate wing at a time)

12.3 Visualisation of alarms and faults



WARNING: the visualisation of alarms and faults is possible with any visualisation selection. The signalling of alarm messages takes priority over all other displays.

Type of alarm	Display	Description	Operation
Mechanical alarm	M0	M0 - Automation type not selected	Select a type of automation from the AT → AS menu
	M4	M4 - Short circuit - motor 1	Check the connection of motor 1.
	M5	M5 - Short circuit - motor 2	Check the connection of motor 1.
	MB	MB - Absence of motor 1 during an operation	Check the connection of motor 1.
	MC	MC - Absence of motor 2 during an operation (if 2-motor functioning has been set)	Check the connection of motor 2.
	MD	MD - Irregular functioning of motor 1 opening limit switch	Check the connection of the motor 1 opening limit switch.
	ME	ME - Irregular functioning of motor 1 closing limit switch	Check the connection of the motor 1 closing limit switch.
	MF	MF - Irregular functioning of motor 2 opening limit switch	Check the connection of the motor 2 opening limit switch.
	MG	MG - Irregular functioning of motor 2 closing limit switch	Check the connection of the motor 2 closing limit switch.
	MH	MH - Door wing overlap not correct	Check that the motor which is the first to make the opening (M1) is connected as shown in fig. 1.
	MI	MI - Detection of third consecutive obstacle	Check for the presence of permanent obstacles along the stroke of the automation.
	OD	OD - Obstacle during opening - gate wing 1	Check for the presence of obstacles along the automation stroke.
	OE	OE - Obstacle during closure - gate wing 1	Check for the presence of obstacles along the automation stroke.
	OF	OF - Obstacle during opening - gate wing 2	Check for the presence of obstacles along the automation stroke.
OG	OG - Obstacle during closure - gate wing 2	Check for the presence of obstacles along the automation stroke.	
Settings alarm	S6	S6 - Incorrect setting of safety device test	Check the configuration of parameters D6, D8, G8 . If G8 → S41 , D6 and D8 cannot be P41 or S41 .
Service alarm	V0	V0 - Request for maintenance intervention	Proceed with the scheduled maintenance intervention.

Type of alarm	Display	Description	Operation
Internal control panel alarm	I5	I5 - No voltage 0-1 (faulty voltage regulator or short-circuit on accessories)	Check there is no short circuit in connection 0-1. If the problem persists, replace the control panel.
	I6	I6 - Excessive voltage 0-1 (faulty voltage regulator)	Replace the control panel.
	I7	I7 - Internal parameter error - value outside limits	Reset. If the problem persists, replace the control panel.
	I8	I8 - Program sequence error	Reset. If the problem persists, replace the control panel.
	IA	IA - Internal parameter error (EEPROM/FLASH)	Reset. If the problem persists, replace the control panel.
	IB	IB - Internal parameter error (RAM)	Reset. If the problem persists, replace the control panel.
	IC	IC - Operation time-out error (>5 min or >7 min in learning mode)	Manually check that the gate wing moves freely. If the problem persists, replace the control panel.
	IE	IE - Power supply circuit fault	Reset. If the problem persists, replace the control panel.
	IM	IM - MOSFET alarm - motor 1 in short circuit or always ON	Reset. If the problem persists, replace the control panel.
	IN	IN - MOSFET alarm - motor 2 in short circuit or always ON	Reset. If the problem persists, replace the control panel.
	IO	IO - Interrupted power circuit - motor 1 (motor MOSFET open or always OFF)	Reset. If the problem persists, replace the control panel.
	IP	IP - Interrupted power circuit - motor 2 (motor MOSFET open or always OFF)	Reset. If the problem persists, replace the control panel.
	IS	IS - Error on current read circuit test - motor 1	Reset. If the problem persists, replace the control panel.
	IT	IT - Error on current read circuit test - motor 2	Reset. If the problem persists, replace the control panel.
	IU	IU - Error on voltage read circuit test - motor 1	Reset. If the problem persists, replace the control panel.
	IV	IV - Error on voltage read circuit test - motor 2	Reset. If the problem persists, replace the control panel.
	XX	XX - Firmware reset commanded by the simultaneous pressing of the  +  keys.	
	WD	WD - Firmware reset not commanded	

Type of alarm	Display	Description	Operation
Radio operations alarm	R0	R0 - Insertion of a storage module containing over 100 stored remote controls Warning: the RO → MU → 20 setting is made automatically.	To save the system configurations on the storage module, delete any stored remote controls and bring the total to less than 100. Set RO → MU → 10 .
	R3	R3 - Storage module not detected	Insert a storage module.
	R4	R4 - Storage module not compatible with the control panel	Insert a compatible storage module.
	R5	R5 - No serial communication with the storage module	Replace the storage module.
	R6	R6 - Insertion of a specific storage module for testing	
Power supply alarm	P0	P0 - No mains voltage	Check the control panel is powered correctly. Check the line fuse. Check the mains power supply.
	P1	P1 - Microswitch voltage too low	Check the control panel is powered correctly.
Battery alarm	B0	B0 - Battery almost flat	Check battery voltage. Replace battery.
Accessories alarm	A0	A0 - Failure of test of safety sensor on contact 6	Check the device SOFA1-A2 is working correctly. If the supplementary SOF board is not inserted, check the safety test is disabled.
	A1	A1 - Simultaneous safety sensor test on contacts 6 and 8 failed	Check the wiring and correct operation of the safety sensor.
	A3	A3 - Failure of test of safety sensor on contact 8	Check the device SOFA1-A2 is working correctly. If the supplementary SOF board is not inserted, check the safety test is disabled.
	A7	A7 - Incorrect connection of contact 9 to terminal 41	Check that terminal 1 and 9 are correctly connected.
	A9	A9 - Overload on output +LP-	Check the device connected to output +LP- is working properly.
	A6	A6 - Alarm for short-circuit on output -LK+	Check the device connected to output -LK+ is working properly.

13. Troubleshooting

Problem	Possible cause	Alarm signalling	Operation
The control panel does not switch on	No power supply.		Check the power supply cable and the relative wiring
	Overload on output 0-1		Disconnect any loads connected to terminal 1
The automation does not open or close.	No power.		Check power supply cable.
	Short circuited accessories	IS	Disconnect all accessories from terminals 0-1 (a voltage of 24V= must be present) and reconnect them one at a time. Contact Technical Service
	Blown line fuse.		Replace fuse.
	Safety contacts are open.	I-6 I-8 68	Check that the safety contacts are closed correctly (NC).
	Safety contacts not correctly connected or self-controlled safety edge not functioning correctly.	A0 I-6 A1 I-8 A3 68	Check connections to terminals 6-8 on control panel and connections to the self-controlled safety edge.
	Photocells activated.	I-6 I-8	Check that the photocells are clean and operating correctly.
	The automatic closure does not work.		Issue any command. If the problem persists, contact Technical Service
	Motor fault	MB MC	Check motor connection, if the problem persists, contact Technical Service.
The external safety devices are not activated.	Incorrect connections between the photocells and the control panel.		Check that I-6 / I-8 is displayed Connect NC safety contacts together in series and remove any jumpers on the control panel terminal board.
			Check the AP → I6 and AP → I8 setting
The automation opens/closes briefly and then stops.	There is a presence of friction.	MI	Manually check that the automation moves freely and check the R1/R2 adjustment Contact Technical Service
The remote control has limited range and does not work with the automation moving.	The radio transmission is impeded by metal structures and reinforced concrete walls.		Install the antenna outside.
			Replace the transmitter batteries.
The remote control does not work	No storage module or incorrect storage module.	R0	Switch the automation off and plug in the correct storage module.
		R3	Check the correct memorisation of the transmitters on the built-in radio. If there is a fault with the radio receiver that is built into the control panel, the remote control codes can be read by removing the storage module.
		RS	

All the rights concerning this material are the exclusive property of Entrematic Group AB.

Although the contents of this publication have been drawn up with the greatest care, Entrematic Group AB cannot be held responsible in any way for any damage caused by mistakes or omissions. We reserve the right to make changes without prior notice. Copying, scanning or changing in any way is expressly forbidden unless authorised in writing by Entrematic Group AB.

ENTRE//MATIC



Entrematic Group AB
Lodjursgatan 10
SE-261 44, Landskrona
Sweden
www.entrematic.com

